

## Disinfection protocol

After cleaning allow the disinfectant to evaporate between sessions.  
Use the device when all surfaces of the device are dry.

### Cleaning materials

medical disinfectant (with max. 70% isopropyl alcohol)

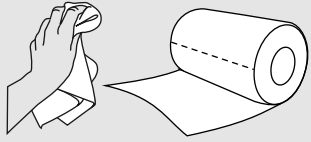

Soft non-scratching disposable cleaning towel



Do **not** use the provided microfiber cloth.

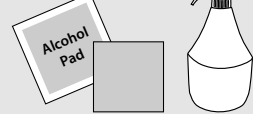

### Cleaning the lightshade

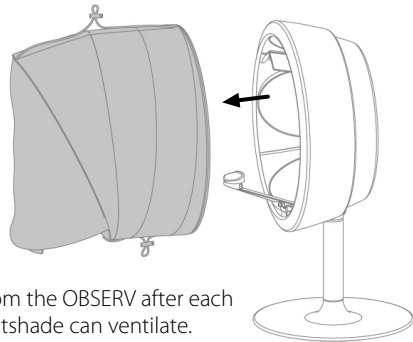

Remove the lightshade from the OBSERV after each use. Both OBSERV and lightshade can ventilate.

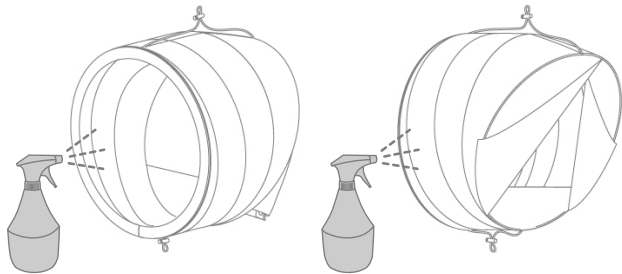

Disinfect the lightshade with medical disinfectant both inside and outside. Leave the lightshade to ventilate. Avoid pooling of liquids.

### Cleaning the device

Use medical disinfectant to clean the iPad and visor.

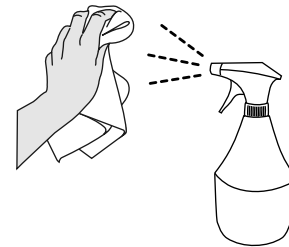
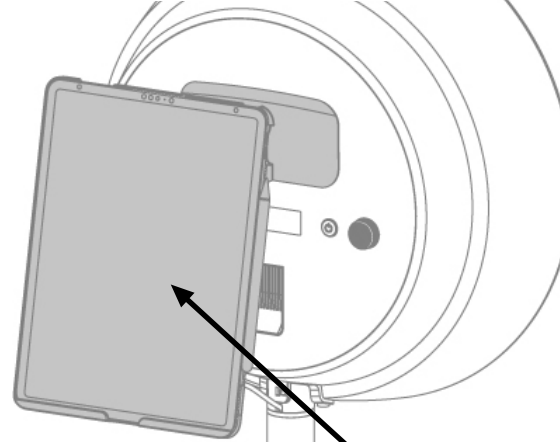

or



All parts in grey can be cleaned using alcohol pads or the non-scratching cleaning towel moistened with medical disinfectant. Avoid pooling of liquids

! Be extra gentle while cleaning the parts in the red area.

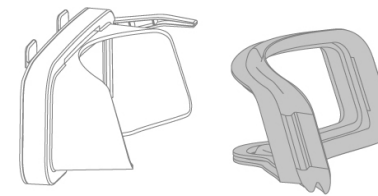
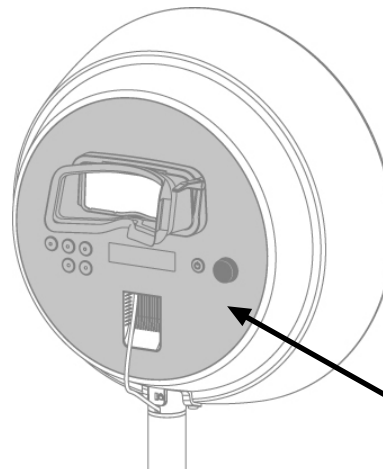
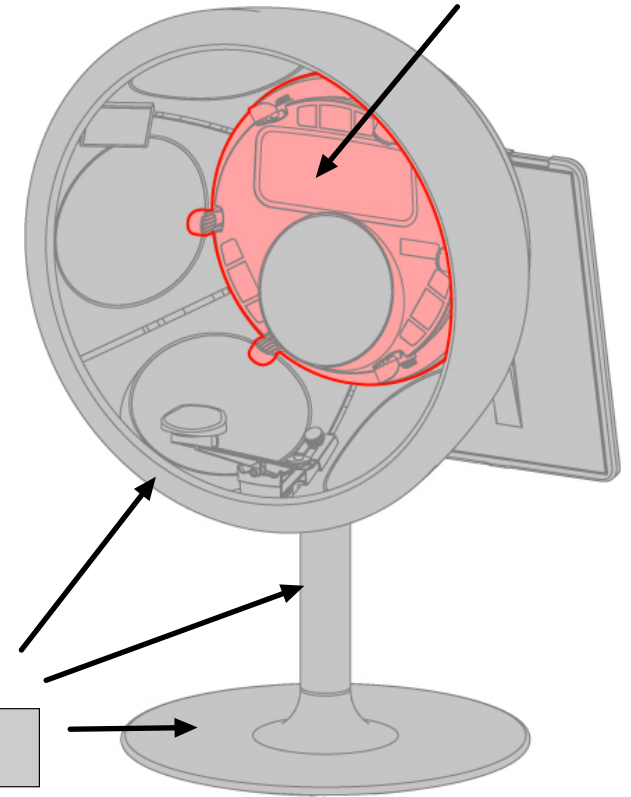

Clean the rubber of the polarisation visor after each use. To disinfect the rubber part remove it from the visor and use medical disinfectant.

Clean the backplate of the Observ.